

Power Control System Kit Installation & User Instructions

K155A – EC155/EC50 Kit (without water level)
K155B – EC155/EC51 Kit (with water level)

Sargent Electrical Services Ltd.

Unit 39, Tokenspire Business Park
Beverley
East Yorkshire
HU17 0TB
United Kingdom

Office Opening Hours

Mon – Thu: 8:00am to 4:30pm
Fri: 8:00am to 12:00pm

Phone: 01482 881655
Fax: 01482 678987
E-mail: support@sargentltd.co.uk

Technical Opening Hours

Mon – Thu: 8:00am to 4:30pm
Fri: 8:00am to 12:00pm

Tech Phone: 01482 678981

EC155A/B Power Control System Kit

1 Kit Contents



* - Only included with K155B kit

150W (~12A) combined Power Converter / Battery Charger - Converts the 230V mains supply into 12V DC power to run the leisure equipment and charge the battery.

Low current switching reduces voltage drop in the circuit and improved circuit fusing provides better protection for the harness and equipment.

Links to the EC5x series LED Control Panel to provide simple but intelligent control of the 12V equipment and built in over discharge software protects the leisure and vehicle batteries.

2 System Overview

The following diagram shows the typical configuration of the EC155 system. The key component is the EC155 power supply unit (PSU), which is the hub of the system and provides connectivity to the ancillary components and the EC5x series control panel.

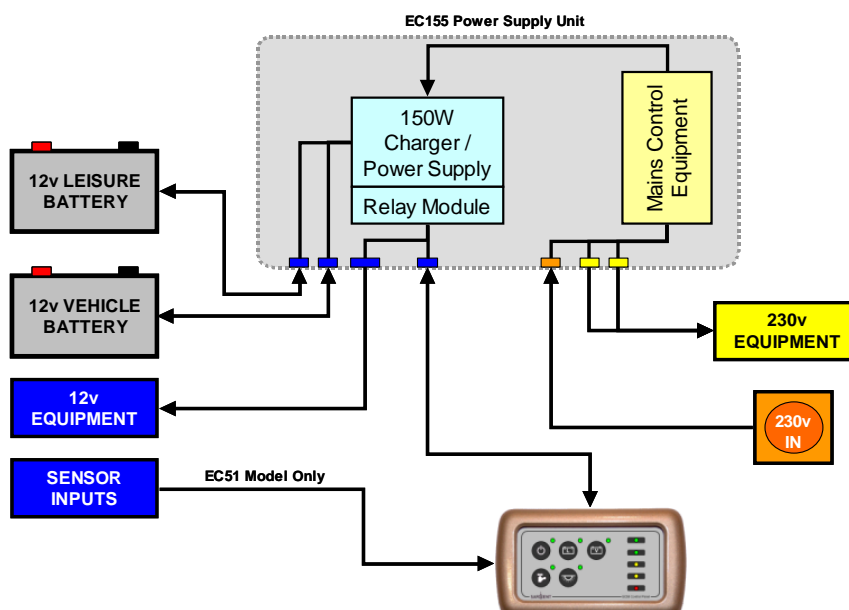

EC155A/B Power Control System Kit

3 Installation

3.1 Location & Mounting

A) Power Supply Unit

Choose a location for the EC155 unit which will provide adequate airflow into the cooling vents (see section 7.2 for recommendations) Ensure there is convenient access to the protective fuses, RCD and MCB's. For optimum cooling mount the unit vertically and fix in position using the four fixing holes provided.

B) Control Panel

Choose a suitable location where the display can be easily viewed, then cut an aperture for fitting (see section 7.2 for size) Plug the communication cable into rear of panel then run back to the Power Supply Unit and attach to matching connector. Avoid running cable alongside mains or ignition circuits to reduce the possibility of interference.

3.2 Water Level Sensors

A) Fresh Water

Drill 5 x 7mm holes in the tank and fit the rubber grommets as shown below. Ensure the DC-VE grommet is fitted below the 25% grommet. Attach wiring harness to each grommet using provided stainless steel bolts and tighten until grommet expands to provide a watertight seal.

B) Waste Water

Drill a 20mm hole in the waste tank then fit sensor from the outside, ensuring it hangs in the open position as shown in the diagram. Tighten the nut until the sensor seals onto the tank.

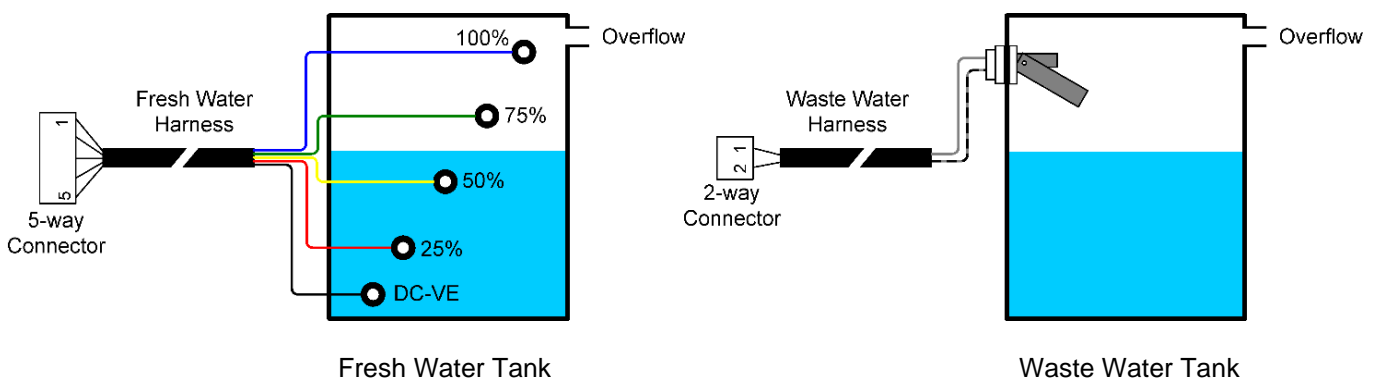

Run the 2-way and 5-way harness back to the control panel and attached to matching connectors. Once all connections are in place fix control panel in place with 2 x screws and fit cover frame to hide fixing screws.

3.3 Power Wiring

WARNING

This equipment must be installed by a competent person or qualified electrician. Install in accordance with all national and local electrical wiring regulations and codes

The EC155 kit is provided with a number of pre-wired harnesses for 12V and 230V power connections. These should be cut to length where required to suit your application. The 230V mains harnesses are terminated with 3-way plugs to ensure safety during installation, these can be removed when hard wiring to appliances.

A) 240V wiring

The mains cables are colour coded for ease of identification and should be wired as shown in the diagram in section 7.11

EC155A/B Power Control System Kit

Plug 4-way input cable into the EC155 unit, then route cable to rear of mains inlet socket (not supplied) and attach Live, Neutral & Earth connections. This cable must not be joined or extended, the earth within the cable must be one continuous piece from the inlet to the PSU.

Connect 4mm earth bond cable to the earth stud provided on chassis of EC155 unit, run the remaining 2 ends to the chassis and then gas pipe (if fitted). The connection to the chassis must include a safety warning label to meet BS7671 requirements.

1x 230V output harness is included with the kit. An optional second output harness can be supplied separately. Plug the 9-way output cables into matching connectors on the EC155 then route around to the mains appliances, clipping the cable at suitable intervals.

B) 12V Wiring

Plug 9-way & 12-way connectors into EC155 unit then route cable to each appliance as shown in the following diagrams:

Caravans with a 13-pin socket – see Section 7.7

Caravans with a 7-pin socket – See section 7.8

Motorhomes – See Section 7.9 & 7.10

C) 12V Fridge Connections

Two types of fridges are generally available for use in caravans and motorhomes. Depending on which type is being used will determine the best position to connect 12V power from the EC155 unit.

Absorption – Also known as 3-way fridges, this type can be powered from a 12V Battery, 230V Mains or LPG gas. They are more suitable for prolonged use away from a mains supply and are generally fitted by manufacturers. As they require a large amount of power when operating from a 12V supply (typically up to 15 Amps) it is recommended they are powered from the vehicle battery only whilst the engine is running.

Compressor – This type can be powered from a 12V Battery and sometimes 230V Mains. They are more suitable for DIY fitment in smaller vehicles such as camper vans and require less power when operating from a 12V supply (typically up to 5 Amps). For this reason, they can be connected directly to the leisure battery (via a fuse), so they can be used whilst driving or stationary.

See sections 7.7 – 7.10, for recommended supply connections for each fridge and vehicle type.

D) Engine Run (D+) Signal

When the vehicles engine is running, there are a number of things the EC155 system will do

- Provide 12V power to the fridge (for absorption type fridges)
- Isolate 12V habitation circuits (to comply with EMC legislation)
- Connect Leisure battery to Vehicle battery/alternator (split charging function)

In order to do this, the system normally uses a relay fed from the vehicles engine run (D+) signal, which will only activate once the engine is running. On some vehicles the D+ signal may not be easy to locate or may not be available, in which case fitting a Voltage Sensing Relay (VSR) may be a solution.

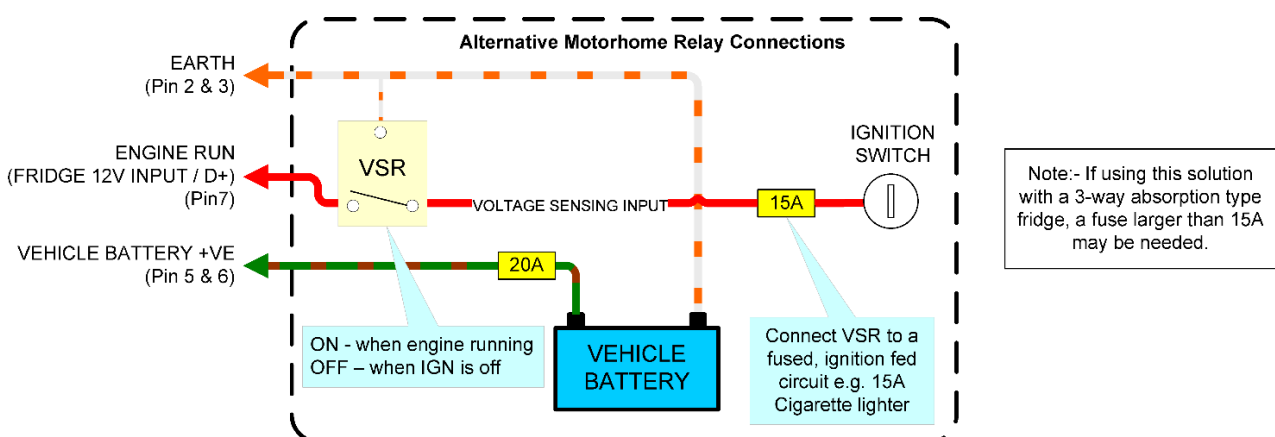

This type of relay will activate once the vehicle engine is running and the alternator starts charging the battery (normally when above 13.7V) and will de-activate after the vehicle's ignition is switched off (normally when below 12.8V).

EC155A/B Power Control System Kit

Note: This solution will not be effective on vehicles with a smart alternator fitted, as the alternator may switch off once the vehicle battery is fully charged and thus de-activate the VSR relay.

E) Battery to Battery Chargers

On Euro6 compliant vehicles fitted with a smart alternator, it may be desirable to fit a DC-DC charging unit, for most effective charging of the Leisure battery whilst driving (also known as Battery to Battery chargers). In order for this to work, the integrated split charging relay within the EC155 will need to be deactivated to avoid it bypassing the DC-DC unit. See section 7.11 for suggested wiring to achieve this.

4 Power Supply Details

For the safe operation of all electrical equipment within your Leisure Vehicle it is important that you read and fully understand these instructions. If you are unsure of any point please contact your dealer / distributor for advice before use.

The following diagram shows the EC155PSU layout.

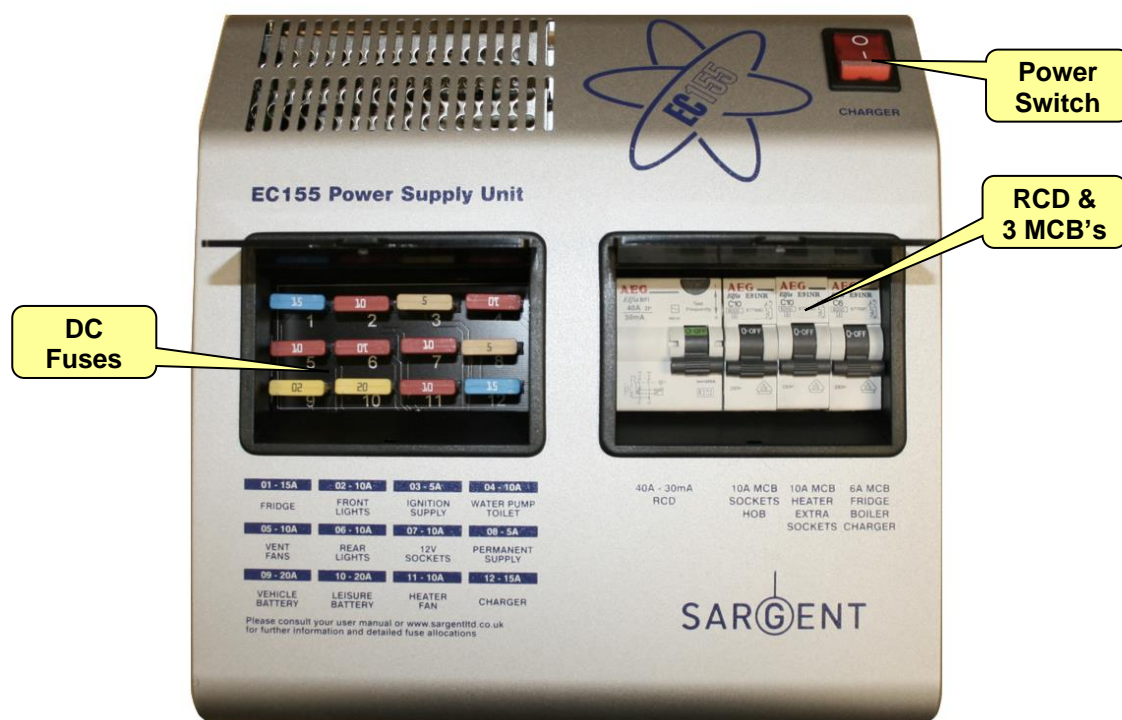

WARNING

Under heavy loads the EC155PSU case may become hot. ALWAYS ensure the ventilation slots have a clear flow of air. Do not place combustible materials against / adjacent to the EC155PSU. The PSU will shutdown if overheated and will restart automatically when cool.

4.1 Battery Charger / Power Converter

The EC155PSU incorporates a fixed voltage battery charger / power converter. The battery charger / power converter also powers the leisure equipment when the mains supply is connected. This module supplies 13.8V DC to the leisure equipment up to a maximum of 12 Amps (155 Watts), therefore the available power is distributed between the leisure load and the battery, with the leisure load taking priority as per the following example:

Leisure load	Available power for battery charging
3A	9A
6A	6A
9A	3A
12A	0A

EC155A/B Power Control System Kit

4.2 Residual Current Device & Miniature Circuit Breakers

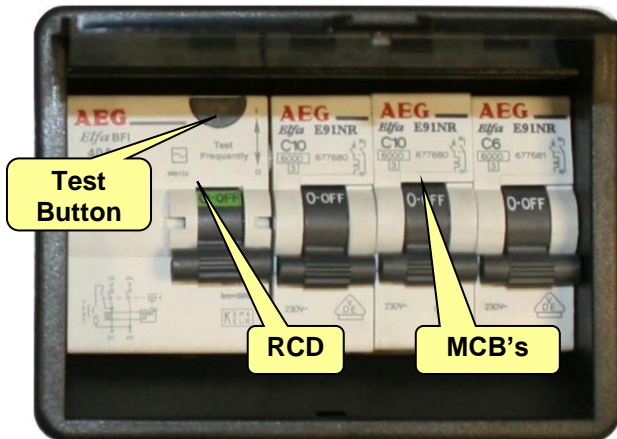

The Residual Current Device (RCD) is basically provided to protect the user from lethal electric shock. The RCD will turn off (trip) if the current flowing in the live conductor does not fully return down the neutral conductor, i.e. some current is passing through a person down to earth or through a faulty appliance.

To ensure the RCD is working correctly, the test button should be operated each time the vehicle is connected to the mains supply (see section 5.1)

The Miniature Circuit Breakers (MCB's) operate in a similar way to traditional fuses and are provided to protect the wiring installation from overload or short circuit. If an overload occurs the MCB will switch off the supply. If this occurs you should investigate the cause of the fault before switching the MCB back on.

The following table shows the rating and circuit allocation for the three MCB's

MCB	Rating	Wire Colour	Description
1	10 Amps	White	230V Sockets
2	10 Amps	White (Yellow for heater)	Extra 230V Sockets / Heater
3	6 Amps	Black (Blue for water heater)	Fridge / Water Heater / 12V Charger (internally connected)

4.3 Fuses

WARNING

When replacing fuses always replace a fuse with the correct value. NEVER replace with a higher value / rating as this could damage the wiring harness. If a replacement fuse 'blows' do not keep replacing the fuse as you could damage the wiring harness. Please investigate the fault and contact your dealer.

The following table shows the fuse allocation for the 12 fuses fitted to the EC155PSU.

Fuse	Rating	Fuse Colour	Description
1	15 Amps	Blue	12V Fridge (Absorption / 3-way type)
2	10 Amps	Red	Front Lights
3	5 Amps	Tan	Hob and Heater Igniters Supply
4	10 Amps	Red	Water Pump / Toilet
5	10 Amps	Red	Ventilation Fans
6	10 Amps	Red	Rear Lights
7	10 Amps	Red	12V Sockets / TV Amplifier / Entertainment
8	5 Amps	Tan	Permanent Supply - Radio / 12V Fridge (Electronics)
9	20 Amps	Yellow	Vehicle Battery
10	20 Amps	Yellow	Leisure Battery
11	10 Amps	Red	Heater Fan
12	15 Amps	Blue	Charger

The following table shows details of the fuse(s) located at the Leisure battery.

Battery 1	20 Amps	Yellow	Brown / Blue	Fuse remotely located near battery
-----------	---------	--------	--------------	------------------------------------

EC155A/B Power Control System Kit

4.4 Battery

A) Type / Selection

For optimum performance and safety, it is essential that only a proprietary brand LEISURE battery is used with a typical capacity of 75 to 120 Ah (Ampere / hours). A normal car battery is NOT suitable. This battery should always be connected when the system is in use.

The EC155PSU is designed to charge standard lead acid leisure batteries, however it may be used with Gel batteries depending on their composition. Please consult the battery documentation for further advice.

The battery feed is fitted with an inline fuse between the battery and the electrical harness, and is usually located immediately outside the battery compartment or within 500mm of the battery. The maximum rating of this fuse is 20A per battery.

B) Installation & Removal

Always disconnect the 230V mains supply and turn the EC155PSU charger switch to the OFF (0) position before removing or installing the battery.

When connecting the battery, ensure that the correct polarity is observed (black is negative [-] and red is positive [+]) and that the terminals are securely fastened. Crocodile clips must not be used.

WARNING

Explosive gases may be present at the battery. Take care to prevent flames and sparks in the vicinity of the battery and do not smoke.

C) Operation / Servicing

Under normal circumstances it should not be necessary to remove the battery other than for routine inspection of the terminals and “topping up” of the battery fluid where applicable. Please see instructions supplied with the battery.

Note: Do not over discharge the battery. One of the most common causes of battery failure is when the battery is discharged below the recommended level of approximately 10V. Discharging a battery below this figure can cause permanent damage to one or more of the cells within the battery.

To prevent over discharge, the EC155PSU in conjunction with the EC5x series control panel incorporates a battery protect circuit that warns and then disconnects the batteries when they fall below the following conditions:

Battery	Voltage cut off	Action after cut off	Notes
Vehicle	10.9V	Battery selection is changed from Vehicle battery to Leisure battery. If the leisure battery is below 9v then a further warning will occur (see below).	This cut off level is designed to protect the vehicle battery from over discharge. The 10.9V level ensures there is sufficient power in the battery to run the vehicle electronics and start the vehicle. This cut off only applies to power drawn from the battery by the leisure equipment; it will not protect the battery if you leave the vehicle lights on.
Leisure	9V	Power is turned off	This is an emergency cut off level to protect the battery from severe damage. You should not rely on this cut off level during normal operation, but manage your power consumption to a discharge level of 10V. This cut off only applies to power drawn from the battery by the leisure equipment that is controlled by the control panel power switch; it will not protect the battery from discharge by the radio or other permanently connected equipment.
Note: the system also incorporates an over voltage cut-out which turns the system power off if either battery voltage exceeds 15V (indicated by the level display top LED flashing).			

EC155A/B Power Control System Kit

5 Control Panel Details

5.1 Layout and Buttons

The following diagram shows the control panel layout and button functions (EC50 control panel).

Note: to remove the decorative bezel, **pull down** and **lift forward** as indicated by the **blue** arrow.

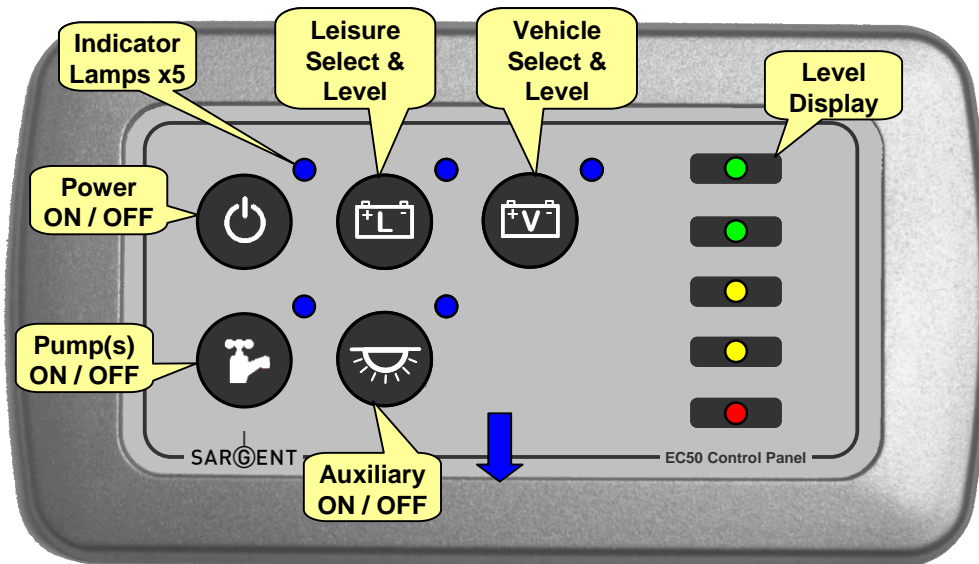

EC50 version of the control panel (without water level display)



5.2 Operation

Symbol	Function	Description
	Main 12v Power switch	This switch turns on (or off) the 12-volt power. As the power is turned on the Leisure battery is automatically selected and the LED display shows the battery voltage. The power is turned off automatically when the engine is started. See also 4.3 below.
	Water Pump power switch	This switch turns on power to the internal water pump ready for use. It can be used to turn off the pump over night to avoid any noise from the pump. When the switch is on, the LED will show Blue when the fresh water tank level is ¼ or above, and Red if the level is under ¼. See also 4.2.1 below.
	Auxiliary power switch	This switch turns the Awning, Entry or other Lighting on (or off). When the switch is on the LED will show Blue.
	Select LEISURE battery and display battery voltage	This switch is used to select the Leisure battery and to display the battery voltage level. Press once to select and display the voltage. This display will turn off automatically after 5 seconds. The LED next to the button will show that the battery has been selected. If the Leisure battery drops below 9V the LED will change to Red and an alarm will trigger to warn you that the battery is low. This alarm lasts for 1 minute and then the power will be switched off to protect the battery. See also 4.2.1 below.
	Select VEHICLE battery and display battery voltage	This switch is used to select the Vehicle battery and to display the battery voltage level. Press once to select and display the voltage. This display will turn off automatically after 5 seconds. The LED next to the button will show that the battery has been selected. If the Vehicle battery drops below 10.9V the LED will change to Red an alarm will trigger to warn you that the battery is low. This alarm lasts for 1 minute and then the battery selection will automatically switch over to the Leisure battery to protect the vehicle battery. See also 4.2.1 below.

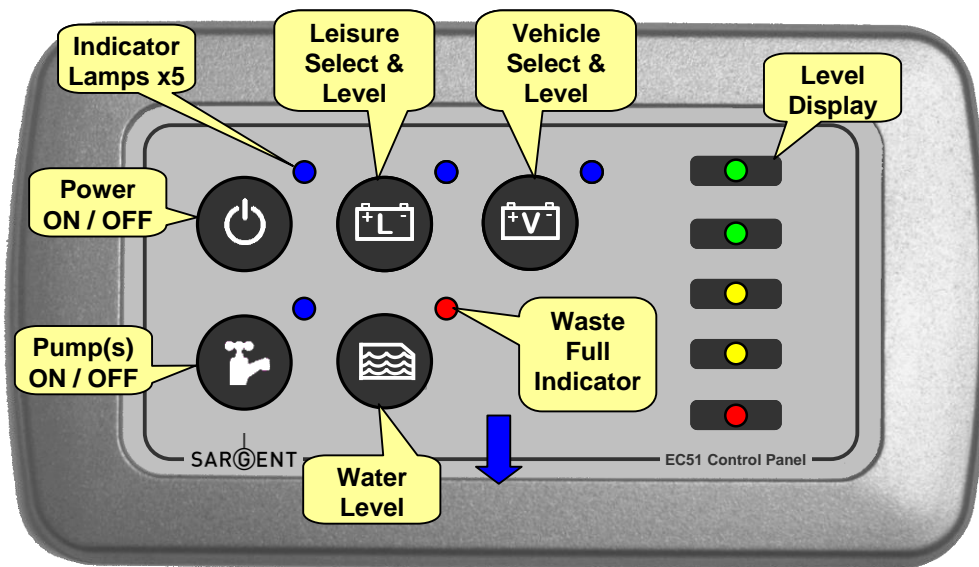
EC155A/B Power Control System Kit



EC51 version of the control panel (with water level display)

	Water Level test	This switch is used to display the fresh water level within the onboard water tank. Press once to select the Fresh tank and show the water level. The tank has 5 levels Empty, ¼, ½, ¾ and Full. This display will turn off automatically after 5 seconds.
	Waste Full indicator	The LED adjacent to the water level button is used to show when the Waste Water Tank is full. The tank is full when the LED is illuminated.

5.2.1 Audible Warnings

The revision 2 control panels now include an audible warning.

If the leisure or vehicle battery warnings are triggered (see 3.4.C) a beeper will sound to draw your attention to the problem. The beeper and the warning can be cancelled by pressing any button. To avoid any warning becoming a nuisance it will only be delivered once whilst the power remains on. The warning will be reactivated when the power has been off and then turned on again.

On EC51 control panels, if the pump is turned on and the fresh water level falls below ¼ a beeper will sound to draw your attention to the problem. The beeper and the warning can be cancelled by pressing any button. If the pump is turned on and the waste tank becomes full a beeper will sound to draw your attention to the problem. The beeper and the warning can be cancelled by pressing any button. To avoid any warning becoming a nuisance it will only be delivered once whilst the pump remains on. The warning will be reactivated when the pump has been off and then turned on again.

5.3 System Disable

To meet EMC (Electro Magnetic Compatibility) directive 89/336/EEC the EC50 series control panel will shut down, and the electrical accessories within the vehicle will be disconnected while the vehicle is in motion. During this state the Leisure and Vehicle button LED's will flash to indicate the engine is running and the leisure battery is being charged from the alternator.

When the engine is stopped, the control panel returns to standby mode ready to be turned on by the power button.

5.4 Bar Graph Technical data

LED	Colour	Voltage reading	Water reading
14V	Green	13.5 - 15 (>15 LED Flashes)	Full
13V	Green	12.5 - 13.5	¾

EC155A/B Power Control System Kit

12V	Yellow	11.5 - 12.5	½
11V	Yellow	10.5 - 11.5	¼
10V	Red	<= 10.5 (<9 LED Flashes)	Less than ¼

6 Operational & Safety Information

6.1 Connecting to the Mains supply - Safety checks

For your safety it is **IMPORTANT** that you follow these connections instructions each time your Leisure Vehicle is connected to a mains supply.

- A) **Ensure suitability of the Mains Supply.** Your Leisure Vehicle should only be connected to an approved supply that meets the requirements of BS7671. In most cases the site warden will hold information regarding suitability of supply. If using a generator, you also need to comply with the requirements / instructions supplied with the generator. Please note that some electronic generators may not be compatible with your leisure system.
- B) **Switch the EC155PSU internal Power Converter OFF.** Locate the red 'Charger' power switch on the EC155PSU and ensure the switch is in the OFF (0) position before connection to the mains supply.
- C) **Connect the Hook-up Lead.** Firstly, connect the supplied hook-up lead (orange cable with blue connectors) to the Leisure Vehicle and then connect to the mains supply.
- D) **Check Residual Current Device operation.** Locate the RCD within the EC155PSU and ensure the RCD is switched on (lever in up position). Press the 'TEST' button and confirm that the RCD turns off (lever in down position). Switch the RCD back to the on position (lever in up position). If the test button failed to operate the RCD see section 5.2.
- E) **Check Miniature Circuit Breakers.** Locate the MCB's within the EC155PSU (adjacent to the RCD) and ensure they are all in the ON (up) position. If any MCB's fail to latch in the on position see section 5.2.
- F) **Turn the EC155PSU ON.** Locate the red power switch on the EC155PSU and turn to the ON (I) position. The switch will illuminate when turned on.
- G) **Check operation of equipment.** It is now safe to check the operation of the 12V and 230V equipment.

6.2 Common Fault Table

Fault	Possible Cause	Proposed Fix
No 230-volt output from PSU	Connecting lead between the site and Leisure Vehicle not connected	Check and connect lead as per 5.1C Check also input connector at the base of the EC155PSU
	RCD switched off	Reset RCD as per 5.1D
	RCD not operating correctly	Check supply polarity; if the RCD continues to fail contact your Dealer, as there is probably an equipment or wiring fault.
	MCB switched off	Reset MCB by switching OFF (down position) then back ON (up position), if the MCB continues to fail contact your Dealer, as there is probably an equipment or wiring fault.
	No or deficient supply from site	Contact site Warden for assistance
	Other faults	Contact your Dealer
Control Panel Problems	Control Panel has no display	Check batteries & fuses, turn EC155PSU charger switch on, and ensure mains supply is connected. Check control panel connecting lead at EC155PSU and behind Control Panel Contact your Dealer

EC155A/B Power Control System Kit

Fault	Possible Cause	Proposed Fix
	12V Power turns off	Battery save feature has operated to protect the Vehicle battery and or the Leisure battery. See 3.4C Engine has been started; all equipment has been disconnected to meet EMC requirements (Battery LED's flashing). See 4.3
	Control Panel display corrupt / erratic function	Observe control panel handling instructions Control panel software may have crashed. Reboot control panel by turning off the EC155PSU charger switch and removing fuses 9 & 10 at the EC155PSU (2x20A fuses for leisure and vehicle batteries). Wait 30 seconds then replace the fuses and turn the charger switch on. (Alternatively, remove the bezel at the control panel by pulling down in the centre at the bottom, unplug the control panel multi-way connector, wait 30 seconds, then plug back in and reassemble.)
No 12-volt output from PSU	No 230V supply	Check all above
	Charger not switched on	Switch charger switch on (I) position, switch will illuminate
	Battery not connected and / or charged	Install charged battery as per 3.4
	Power switch on control panel not switched to ON	Turn power on at control panel
	Battery flat / Battery fuse blown	Recharge battery, check fuses, check charging voltage is present at battery
	Fuse blown	Check all fuses are intact and the correct value fuse is installed as per fuse table
	Equipment switched off / unplugged	Check equipment is switched on and connected to the 12V supply
	PSU overheated / auto shutdown operated	Reduce load on system. Allow PSU to cool down. PSU will automatically restart when cool. See section 3
	Other faults	Contact your Dealer
Pump not working	Fuse blown	Replace fuse
	Pump turned off	Turn pump on by pressing the pump button at the EC155 control panel (tap symbol)

EC155A/B Power Control System Kit

7 Technical Data & Approvals

7.1 Outline Specification

INPUT 230V	230 Volts / 0 to 12 Amps	+ / - 10%
OUTPUT 230V	RCD protected, 3 x MCB outputs of 10, 10 and 6A via 2 x 9-way connectors	
INPUT 12V	2 x 20A battery inputs via a single 9-way connector	
OUTPUT 12V	20A total output via 4 x 16A switched channels protected by 12 fused outputs via a 12-way connector	
Integrated CHARGER	Input 220-240 Volts AC +/- 10%, Frequency 50 Hz +/- 6%, Current 3A max. DC Output 13.8 Volts nominal, Current 12 Amps max (155 Watts).	
Signal INPUT	1 x Engine running via PSU connector (4 x Fresh water level, 1 x Waste water level on EC51 version)	Fresh & waste water negative sensed
Data IN / OUT	Data communication and power to Control Panel via 8-way RJ45 connector	
IP rating	IP31	
Operating temperature	Ambient 0 to 35° Centigrade PSU case temperature with full load 65° C Max	Automatic shutdown and restart if overheated / overloaded

7.2 Dimensions

EC155PSU	Overall size (HxWxD) 260 x 273 x 110mm	Fixing centres 262 x 224mm
	Clearances 75mm above, 20mm below, 50mm left & right	Weight 2.2 Kg
EC50/51 Control Panel	Overall size (HxWxD) 80 x 140 x 30mm	Fixing centres 123mm
	Cut-out size (HxW) 60 x 110mm	Weight 100 g

7.3 Approvals

System: BSEN 1648-1, BSEN1648-2 compliant, BS7671: 2008 compliant

Residual Current Device: RCD 40A 30mA trip to BS EN 61008

Miniature Circuit Breakers: MCB's (10 & 6A) type C 6000A breaking capacity to BSEN 60898

Electro Magnetic Compatibility (EMC) directive 89/336/EEC

Integrated Charger Module: BS EN 60335-1/2.29, 89/336/EEC, IEC61000-3.2/3:1995, EMC certificate 5A121501E 3rd party tested.

7.4 Declaration of Conformity

Equipment: Leisure Power Control System

Model name: EC155PSU / EC50CP / EC51CP / EC52CP

I hereby declare that the equipment named above has been designed to comply with the relevant sections of the above referenced approvals. The unit complies with all essential requirements of the Directives.

Signed:	Name:	Position:	Manufacturer:
	I L Sargent	Technical Director	Sargent Electrical Services Ltd Unit 39, Tokenspire Business Park Woodmansey, Beverley East Yorkshire, United Kingdom
Date: 4 th Aug 2020			

EC155A/B Power Control System Kit

7.5 Electrical Connections – Power Supply Unit

A) Battery Input Connector

Pin	Function	Fuse	Wire Colour
1	Fridge 12V output (Absorption)	1	RED / YELLOW
2	Battery common earth 1	-	WHITE / ORANGE
3	Battery common earth 2	-	WHITE / ORANGE
4	Auxiliary 12V output	2	SLATE / RED
5	Vehicle battery input 1	9	BROWN / GREEN
6	Vehicle battery input 2	9	BROWN / GREEN
7	Engine Run (Fridge 12V input / D+)	-	RED
8	Leisure battery input 1	10	BROWN / BLUE
9	Leisure battery input 2	10	BROWN / BLUE

B) 12v Output Connector

Pin	Function	Fuse	Wire Colour
1	Radio / Fridge Electronics	8	BROWN / YELLOW
2	12v Sockets 1	7	YELLOW / WHITE
3	12v Sockets 2	7	YELLOW / WHITE
4	Hob & Heater Ignitors	3	YELLOW / GREEN
5	Front Lights 1	2	SLATE
6	Front Lights 2	2	SLATE
7	Heater fan	11	BLACK / RED
8	Rear Lights 1	6	PINK
9	Rear Light 2	6	PINK
10	Fans	5	BLACK / BLUE
11	Toilet Pump	4	PURPLE
12	Pump	4	PURPLE / BLACK

C) 230v Mains Input connector

Pin	Function	Wire Colour
1	Not used	-
2	Earth	GREEN / YELLOW
3	Live	BROWN
4	Neutral	BLUE

EC155A/B Power Control System Kit

D) 230v Mains output connector (2 off connectors wired identical)

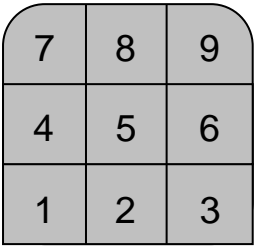
	Pin	Function	MCB	Wire Colour
	1	Live (Sockets/Hob)	1	BROWN
	2	Earth	1	GREEN / YELLOW
	3	Neutral (Sockets/Hob)	1	BLUE
	4	Live (Heater/Extra Sockets)	2	BROWN
	5	Earth	2	GREEN / YELLOW
	6	Neutral (Heater/Extra Sockets)	2	BLUE
	7	Live (Fridge/Boiler/Charger)	3	BROWN
	8	Earth	3	GREEN / YELLOW
9	Neutral (Fridge/Boiler/Charger)	3	BLUE	

7.6 Electrical Connections – Control Panel

A) Fresh water connector

	Pin	Function	Wire Colour
	1	DC-VE	BLACK
	2	25% full Input	RED
	3	50% full Input	YELLOW
	4	75% full Input	GREEN
5	100% full Input	BLUE	

B) Waste water connector

	Pin	Function	Wire Colour
	1	+5V feed to switch	SLATE
	2	Waste switch Input	SLATE / BLACK

C) Communication connector

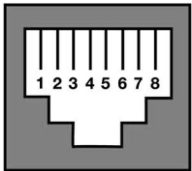
	Pin	Function	Wire Colour
	1	Leisure Battery +12V Input	-
	2	DC-VE	-
	3	Power Status Output	-
	4	Selected Battery Status Output	-
	5	Pump Status Output	-
	6	Vehicle Battery +12V Input	-
	7	Engine Run Input (High=Off)	-
8	Aux Status Output	-	

While every effort has been made to ensure the accuracy and completeness of this document, no guarantee is given against errors or omissions. This document may be updated / improved over time therefore please check with your dealer / supplier for update information or visit www.sargentltd.co.uk

EC155A/B Power Control System Kit

7.7 12V Wiring – Caravans (13-Pin socket)

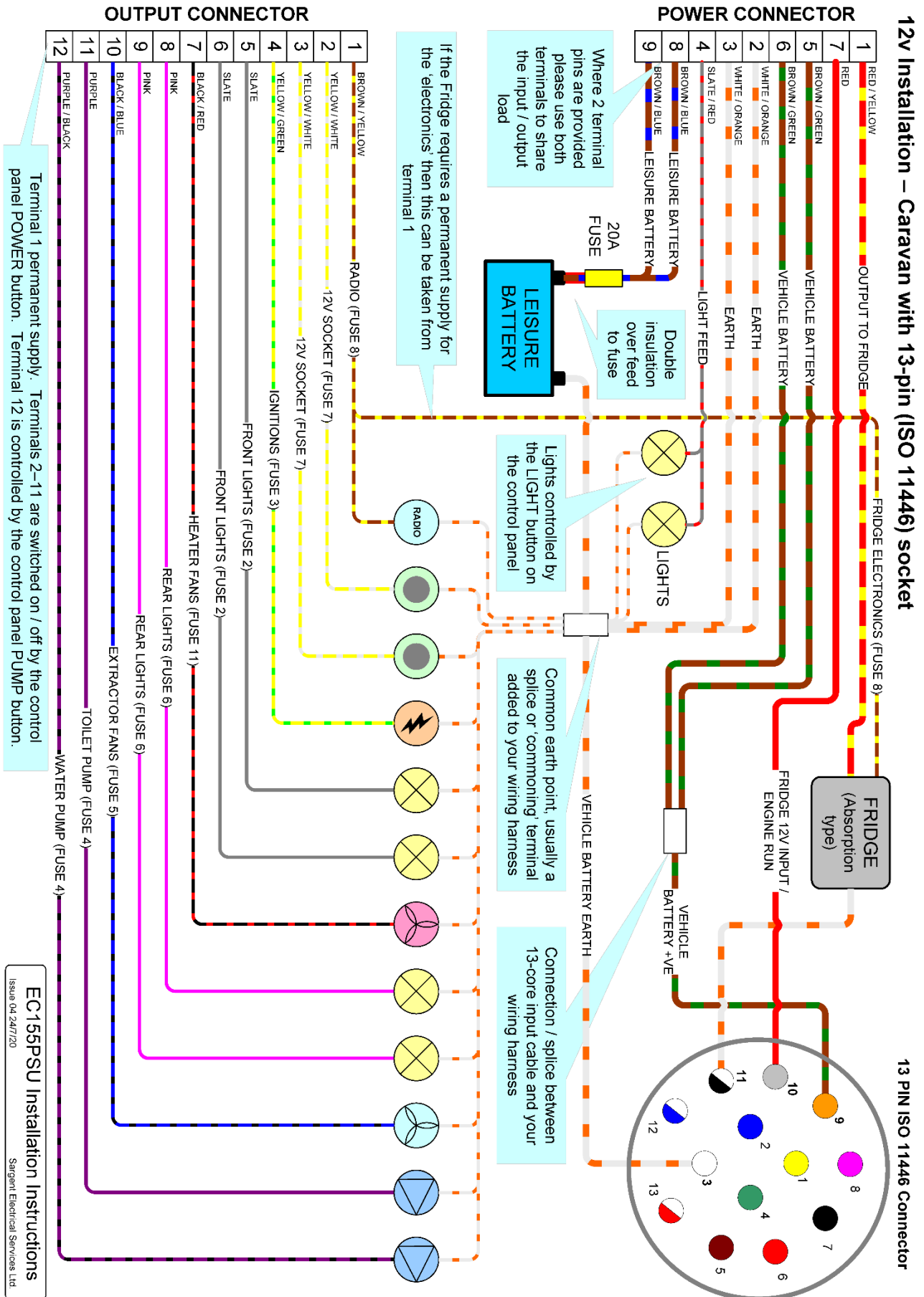

EC155A/B Power Control System Kit

7.8 12V Wiring – Caravans (7-Pin Socket)

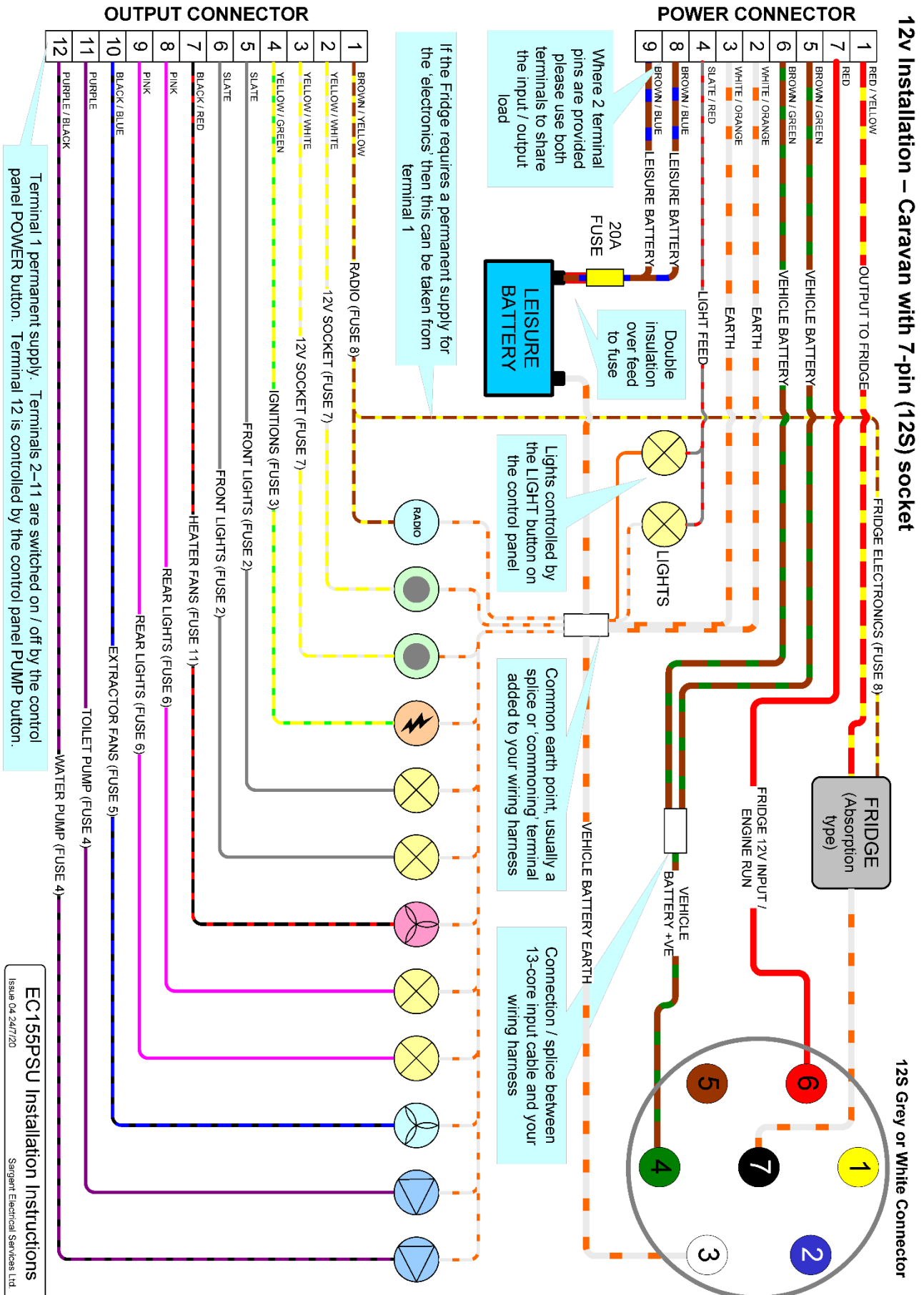

EC155PSU Installation Instructions
Issue 04 24/7/20
Sargent Electrical Services Ltd

EC155A/B Power Control System Kit

7.9 12V Wiring – Motorhomes (Absorption fridge)

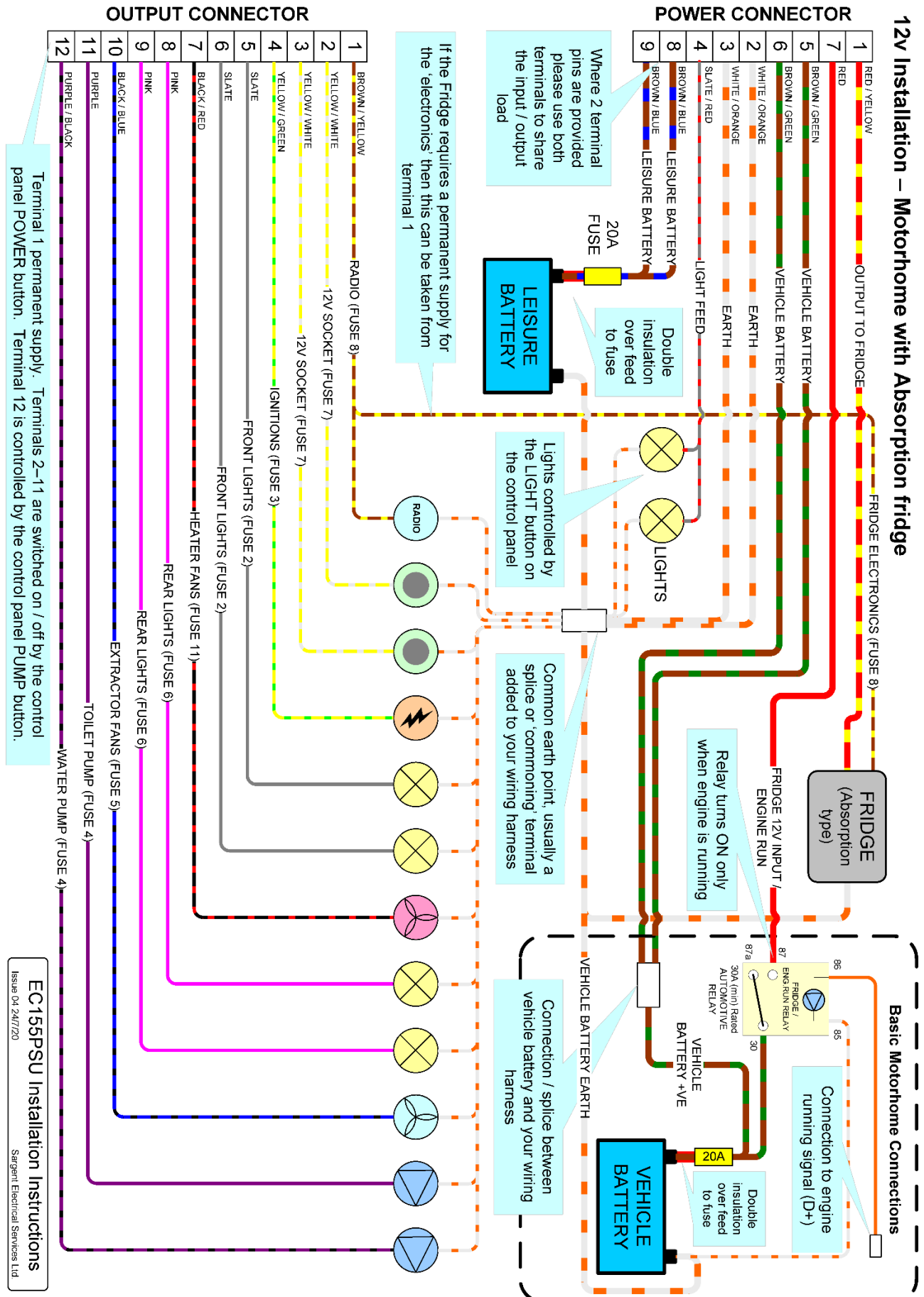

EC155A/B Power Control System Kit

7.10 12V Wiring – Motorhomes (Compressor fridge)

12v Installation – Motorhome with Compressor fridge

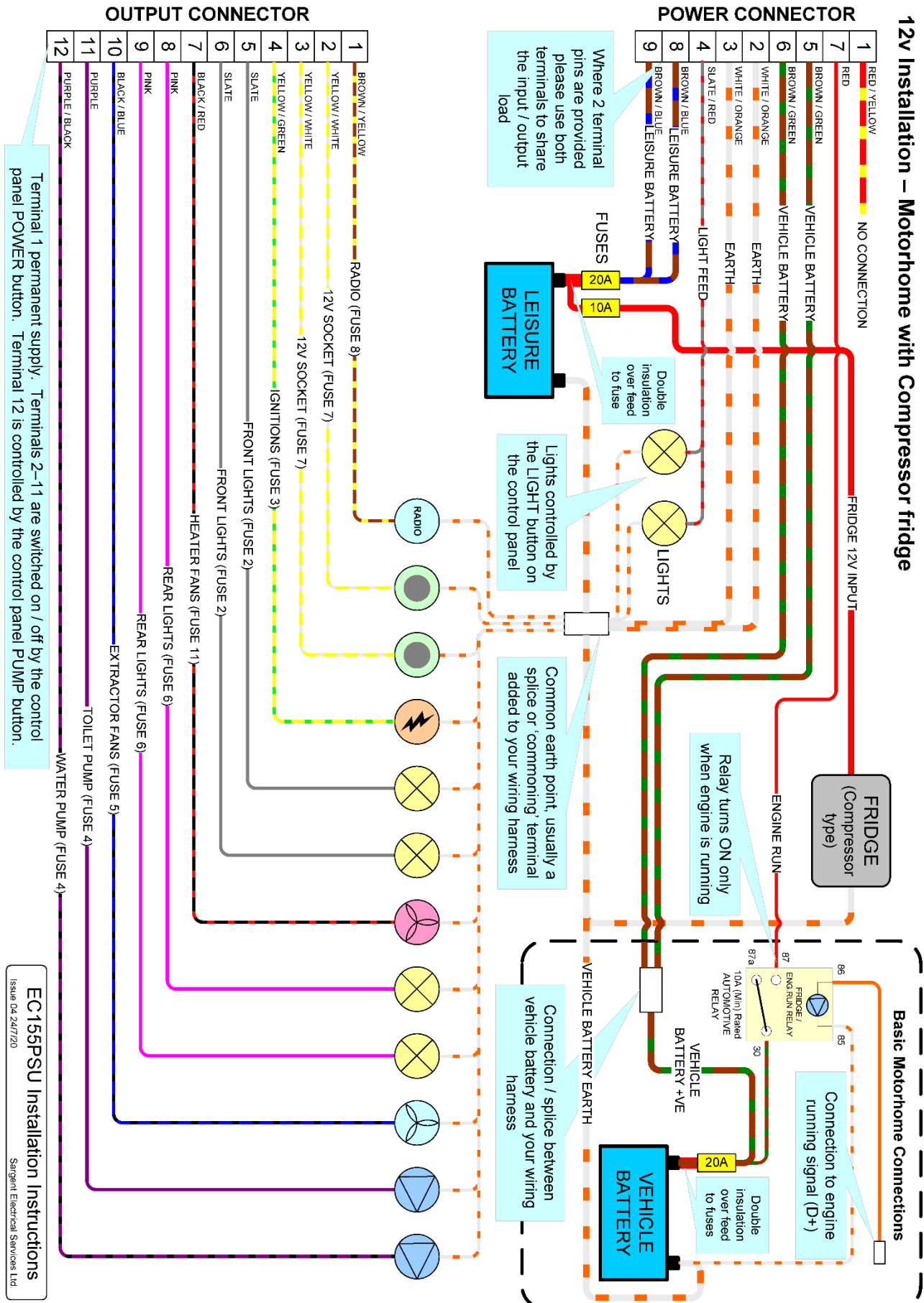

EC155PSU Installation Instructions
Issue 04 24/7/20
Sargent Electrical Services Ltd

EC155A/B Power Control System Kit

7.11 Wiring - Motorhomes with DC-DC Charger

12v Installation – Motorhome with DC-DC Charger fitted

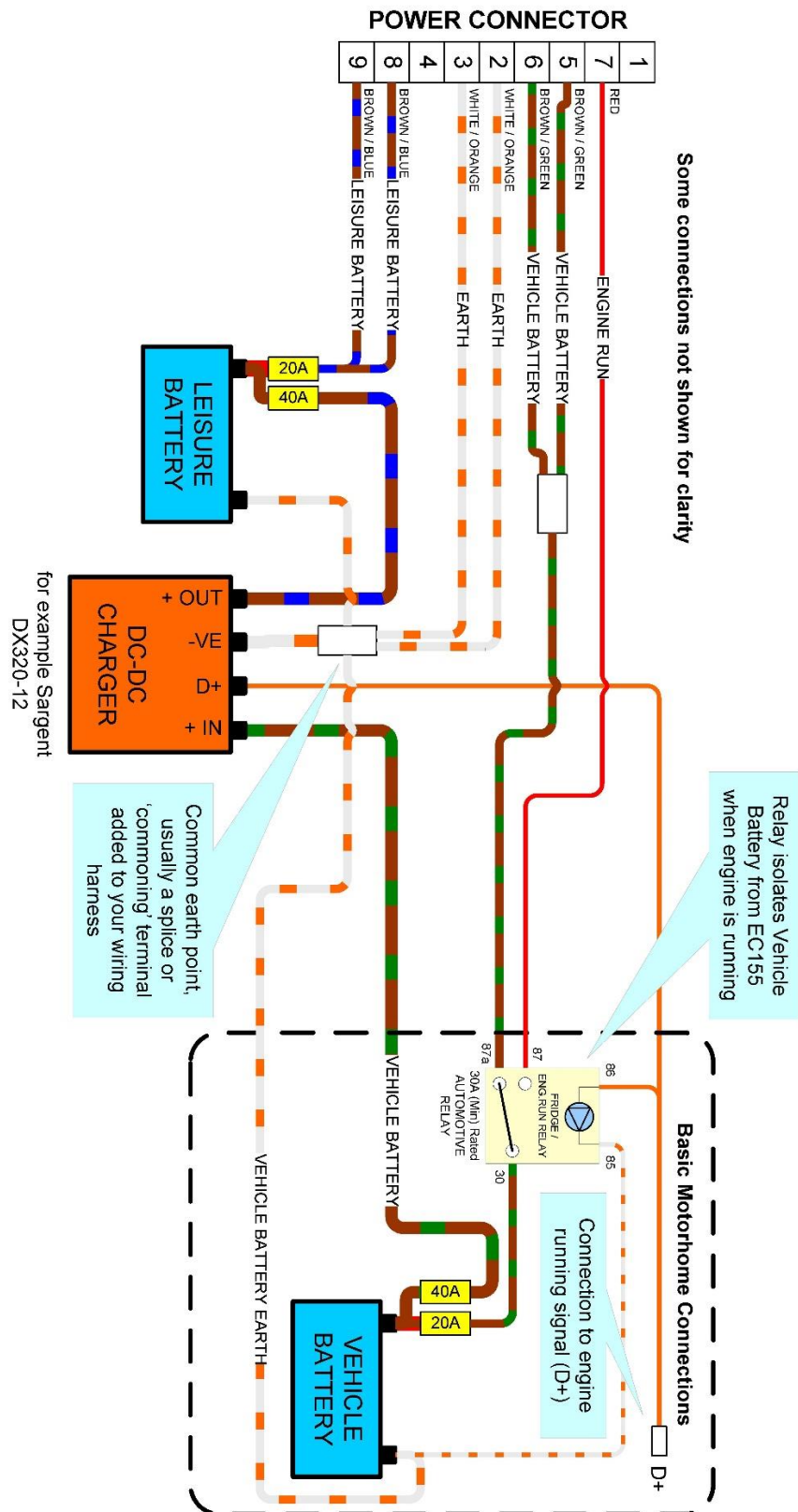

EC155PSU Installation Instructions
Issue 04 24/7/20
Sargent Electrical Services Ltd.

EC155A/B Power Control System Kit

7.12 230V Wiring – Caravans & Motorhomes

